

Article number: 2310415111

Description: E+G Vibration-damping levelling element
LW.A-80-M12x1.25x120

Measures

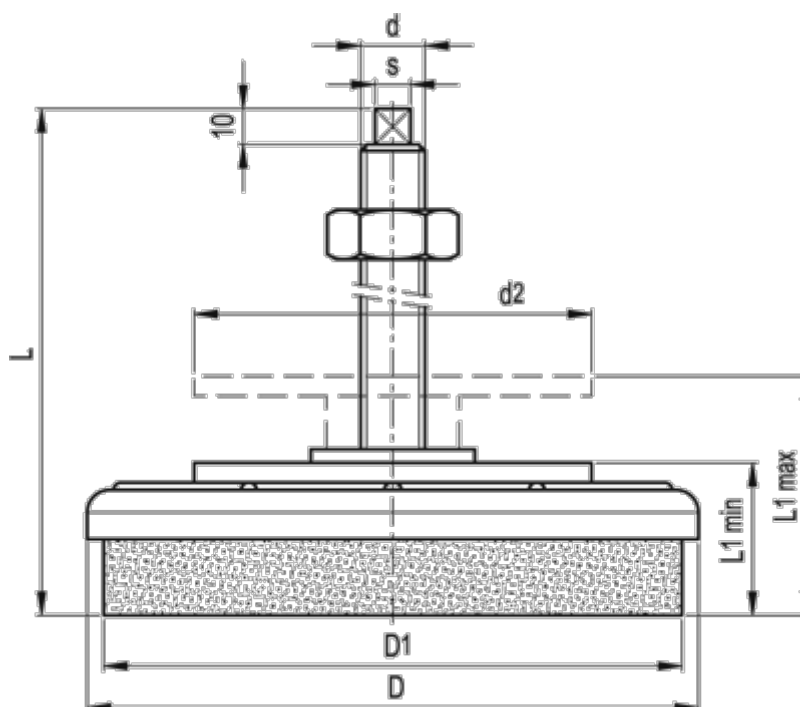

d	= M12x1.25	s	= 8x8
D	= 80	Static load (N)	= 5000
d1	= 72	Stiffness (N/mm)	= 2500
d2	= 60	Weight (g)	= 530
L	= 134		
L1 max.	= 50		
L1 min.	= 38		
Max deflection	= 2.0		